



The town of Provadiya
Tel.: 051844136 Fax: 051846943
Mobile: 0887 496953
Email: impresia@mail.bg
www.impresia.net

TECHNICAL SPECIFICATIONS USER MANUAL FOR INSTALLATION, USE, MAINTENANCE AND CONTROL OF THE EQUIPMENT

Company: IMPRESIA 99 LTD

Combined children play facility, model MM45



I. TECHNICAL SPECIFICATIONS

1. General Characteristics

Model	MM45
Age group	0-3 год.
Maximum free fall height	59 см.
Maximum number of users	6
Size of the facility	151 x 197 x 229 см
Safety zone	20 м2
Types of games	Climbing, sliding, balancing
Admissible surfaces for the fall area	Sand, shock-absorbing synthetic surface
Standards compliance	BS EN1176-1, BS EN1176-3
Warranty period	24 months

2. Dimensions of the Equipment and Minimum Space for Placement

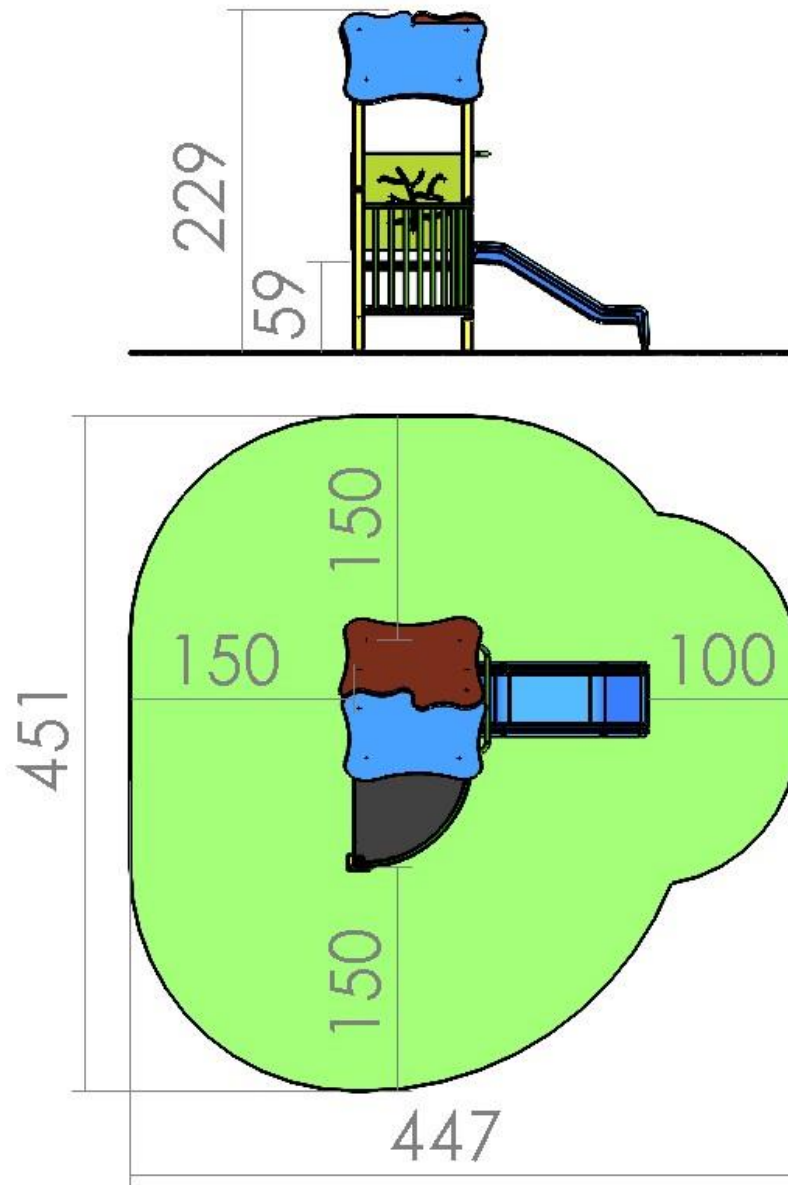

3. Materials Used

1.) Construction of square metal profiles - Solid series

The construction of the facility is made of metal profiles with size 60/60/2, primed with epoxy primer and two-layer painted with polyritan paints for exterior use meeting the requirements of BDS EN1176-1.

The construction of the facility is designed according to the requirements of BDS EN1176-1, both in terms of constant and variable loads, according to the number of users on the area or volume, and in terms of all requirements of this standard for fall protection and protection against all types of grips. All edges are rounded with a radius of 10 mm.

2.) HPL and PVC elements

All reinforcements, belts, brackets, etc., as well as all flat modules, roofs, partitions, portals, game panels, sides of stairs and bridges, vertical climbing walls, tunnels, arches, etc. are made of HPL in different colors and assembled everywhere with bolted connections with hidden heads and nuts secured against unscrewing.

3.) Metal elements involved in the facilities

All other metal elements in the facility - handles, sides of stairs, levers, railings, partitions, etc. they are also hot-dip galvanized and then primed and painted, as well as the construction of the facility. The chemical composition of the coating meets the requirements of BDS EN1176-1.

4.) Platforms, steps, ramps, climbing walls and seats

They are made of wear-resistant, embossed laminated birch plywood for outdoor use with a thickness of 18 mm and additionally protected edges, mounted by a sufficient number of corner plates and metal threaded fittings.

5.) Elements made of rope

A special steel multi-wire rope $\Phi 16$ mm is used for the production of the rope elements. Each of the cores is braided with a polyamide braid that insulates the steel threads.

The connection of the individual ropes to the steel fittings is through extruded aluminum connections, and the connection between the ropes, where they intersect, is through special polyamide balls with divergent transition holes.

6.) Polyethylene elements

All polyethylene elements (seats, protective caps, plugs) are made by injection of high quality colored polyethylene with high density with the addition of the necessary ingredients to ensure the necessary plasticity and resistance to external weathering and UV rays.

7.) Elements of rubber

All rubber elements in the facility are made of colored butadiene styrene rubber SDR with shore80 hardness, meeting the requirements for resistance to weather conditions and UV rays.

8.) Fiberglass slides

High quality polyester resins with the necessary pigments and additives for color and plasticity are used for the production of the slides. The whole structure is multi-layered and reinforced with fiberglass. The work surface and edges are extremely smooth and treated with polyester gel.

All materials used in the production of slides meet the requirements of BDS EN71-3.

All geometric dimensions of the slides meet the requirements of BDS EN1176-1 and BDS EN1176-3.

10.) Joints

Metal, threaded, galvanized fittings with M8, M10 and M12 are used for assembling the individual modules and the construction. All heads of bolts and nuts that are not flat configuration and designed for a special tool are hidden with special caps.

For the fastening of some modules to the structure, galvanized corner plates with the required thickness are used, providing the strength indicators of the module.

II. INSTRUCTION FOR INSTALLATION OF THE EQUIPMENT

The installation of the equipment to the existing terrain is performed as follows:

When installing on a reinforced concrete slab with a thickness of at least 10 cm (according to the constructive opinion of the equipment), the installation is performed by certified segmented anchors. After tightening the anchors, the protruding part is cut out and, after applying the impact absorbing rubber covering, the entire anchoring zone is covered and aligned with the covering with a special rubber jointing mixture.

When installing on a lawn or a terrain with bulk covering (sand or chips), attachment of the equipment is performed by cement stabilization with concrete foundations according to the foundation plan below. The connection of the structure and the concrete foundations is made by metal pillars with welded reinforcement in the area of the foundation. Depending on the type of equipment, these embedded items are a continuation of the supporting pillars (when the equipment has a metal structure) or are a separate element connecting the wooden structure to the foundations. In the case of bulk impact absorbing covering, the supporting metal pillars are stretched depending on the thickness of the covering, so that the foundations can be casted into solid support soil. After the installation of the equipment, the concrete foundations are covered with soil or bulk covering to the level of the terrain.

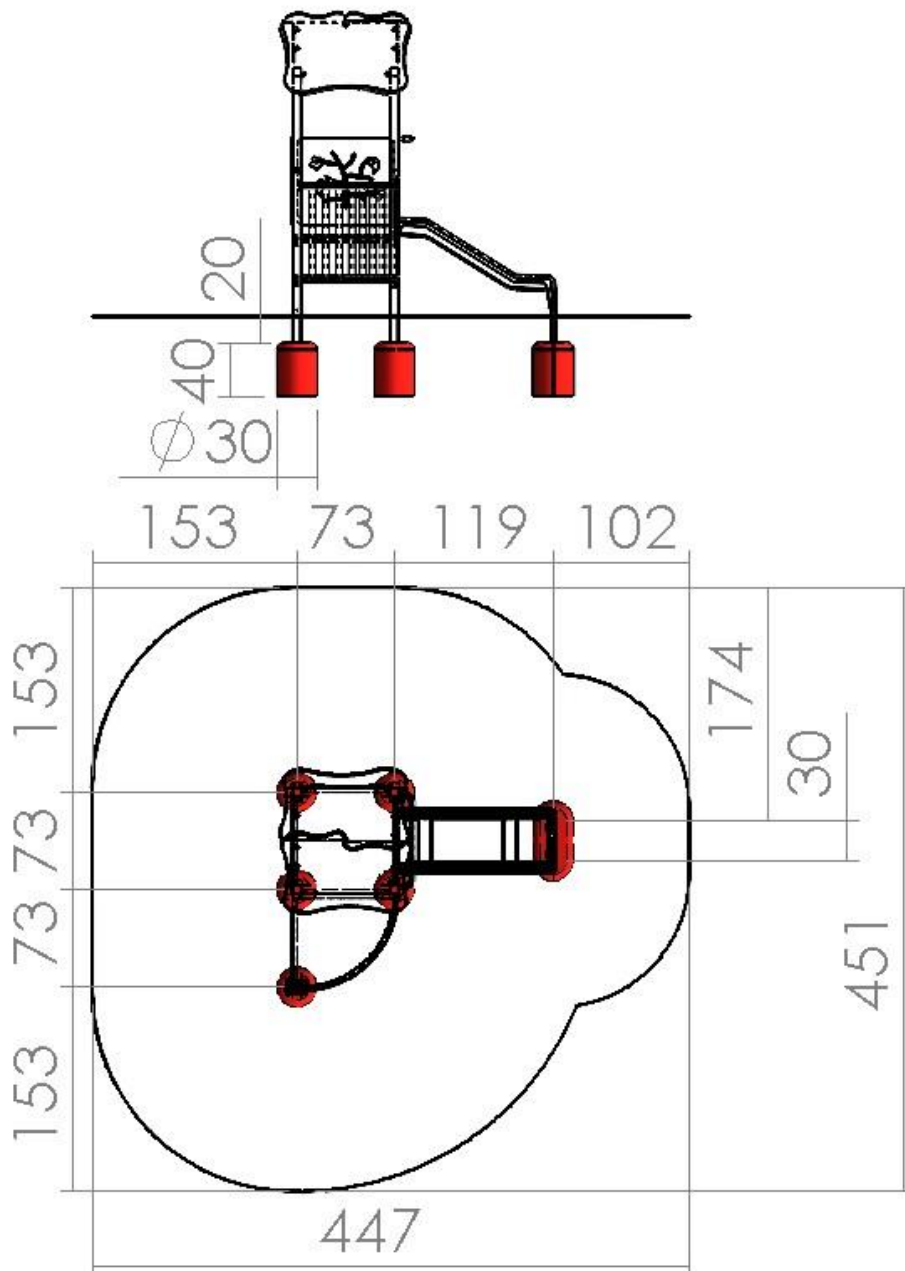

III. OPERATING AND MAINTENANCE INSTRUCTION OF THE SLIDE EQUIPMENT

1. The commissioning of the installed equipment by cement stabilization with concrete foundations shall be performed after the final maturing of the concrete (not less than 48 hours after its washing).

2. The use of the equipment is unacceptable prior to providing the foreseen in the project corresponding impact absorbing covering and the minimum fall and play area provided in this Technical Specification.

3. In order to achieve a longer operating life, it is necessary to perform periodic maintenance of the equipment.

- Despite the fact that the wood used for production is selected and dried, it is a natural material that is expected to expand and collapse over time and it is therefore necessary in the periodic checks described below to check the tightness of the bolt connections and in case of necessity to be tightened.

- It is necessary to periodically clean the equipment from sand and other solid particles, which accelerate the wear of the horizontal or sloping surfaces.

IV. GENERAL INSTRUCTIONS FOR MAINTENANCE OF THE EQUIPMENT

> According to BS EN 1176 and Ordinance № 1 of January 12th, 2009 on the Terms and Conditions for Playgrounds Structure and Safety (State Gazette, issue 10/2009) the equipment is subject to regular, periodic and annual monitoring.

- The regular monitoring is carried out by the owner of the playground once every 7 - 10 days in order to examine for any obvious dangers.

- The periodic monitoring is carried out by the owner of the playground once every 1 - 3 months depending on how often the playground is visited. The periodic monitoring is carried out for the purpose of detailed examination of the functioning and stability of the play facilities due to their wearing.

- The annual monitoring is carried out for the purpose of complete and detailed examination of the overall level of safety on the playground, which should comply with the requirements of the above-mentioned Ordinance.

> In case of any troubles, measures to eliminate the identified hazards and risks for the safe operation of the playground should be taken.

V. GUARANTEE CARD

The warranty period of the product is **24** months from the date of installation.

The warranty period of the performed construction and assembly works - sanding with concrete foundations or anchoring on a reinforced concrete slab is 5 years from the date of commissioning of the site.

The operating period of the product is significantly longer than the warranty period and is largely dependent on the periodic maintenance of the equipment described in the operating instructions and the technical specification.

The warranty period covers the following defects:

- Defects of poor manufacturing quality of the product
- Defects of poor quality materials
- Defects due to poor installation

Product warranty does not apply in the following cases:

- If the product is assembled or installed in a manner contrary to the manufacturer's instructions (when installed by the customer)
- Damages to the product caused by vandalism
- Damages caused by improper use not in accordance with the manufacturer's recommendations stated in the operating instructions
- If the buyer has not performed the necessary checks and maintenance of the product in accordance with the manufacturer's recommendations stated in the operating instructions
- In the case of normal wear and tear resulting from the use of the product for its intended purpose, such as scratches, dents, abrasion, fading, cosmetic problems of surface corrosion, micro cracks in wood not affecting the strength and safety of the product.
- Hidden defects in installation work in anchoring due to a poorly executed concrete foundation (slab) by the client. Such a problem may occur with insufficient covering thickness or poor quality concrete.



For company: "ИМПРЕСИА 99" OOD