

TECHNICAL SPECIFICATIONS USER MANUAL FOR INSTALLATION, USE, MAINTENANCE AND CONTROL OF THE EQUIPMENT

Company: IMPRESIA 99 LTD

Combined children play facility, model КДС97



I. TECHNICAL SPECIFICATIONS

1. General Characteristics

Model	КДС97
Age group	2 - 6 y. o.
Maximum free fall height	60 cm.
Maximum number of users	10
Size of the facility	376x242x205 cm
Safety zone	34 m ²
Types of games	Climbing, sliding, balancing
Admissible surfaces for the fall area	Sand, shock-absorbing synthetic surface
Standards compliance	BS EN1176-1, BS EN1176-3
Warranty period	24 months

2. Dimensions of the Equipment and Minimum Space for Placemen

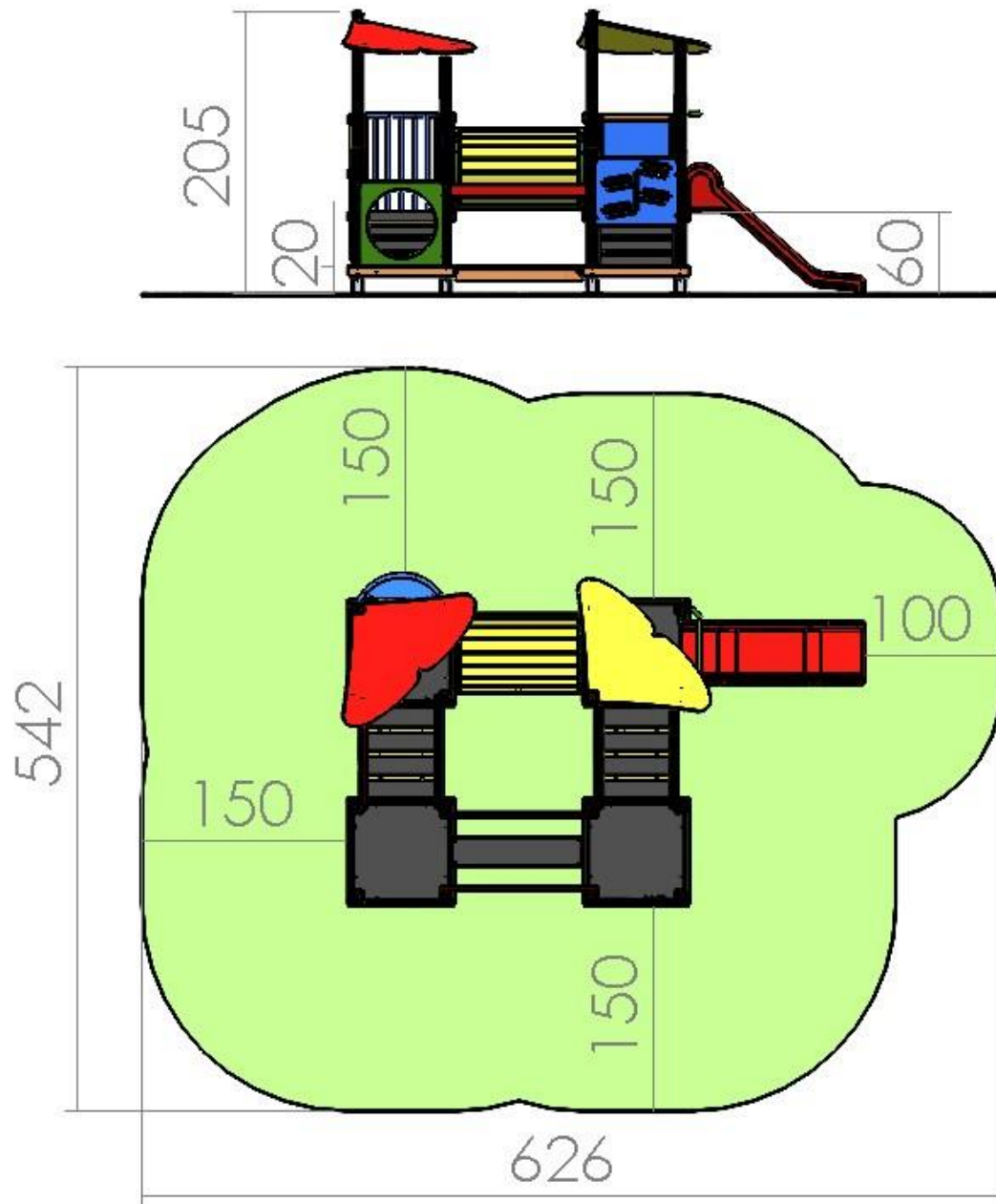

3. Materials Used

❖ Structure of wooden profiles – Optima series

The structure of the equipment is made of 2-ply softwood 70x70 mm, dried up to 10% moisture, impregnated with a decay preventing primer and varnished with three layers of ecological acrylic varnishes for exterior use, meeting the requirements of BDS EN1176-1. The profile of the wood of the structure corresponds to the loads when using the equipment.

The structure of the equipment is designed in accordance with the requirements of BDS EN1176-1, both in terms of constant and variable loads, according to the number of users on the respective area or volume, and in terms of all requirements of this standard for protection against falls and protection against all types of grips. All edges are rounded with a radius of 10 mm.

❖ Metal elements involved in the facilities

To strengthen the floor structure of the larger facilities, hidden metal frame structures of profile 80x40, 60x40 and vertical column $\Phi 108 / 2$ are used. The roof structures of the same are

reinforced with metal supports of pipe $\Phi 32 \times 2$. Horizontal pipe tensioners with 32×2 profile were used to strengthen the columns of some of the equipment. Tubular metal handles with profile $\Phi 25 / 2$ are installed at the access means. Metal products are primed with epoxy primer for metal, after degreasing and rust cleaning, and painted with two-component semi-rattan paint for outdoor conditions with high resistance to UV rays and scratches. The chemical composition of the coating meets the requirements of BDS EN1176-1.

❖ **Platforms, steps, ramps, climbing walls and seats**

They are made of wear-resistant, embossed laminated birch plywood for exterior use with a thickness of 18 mm and additionally protected edges, mounted by means of sufficient number of angle plates and metal threaded fasteners.

❖ **Elements of foamed PVC**

The foamed PVC furniture panel is moisture resistant. It has a very low degree of moisture absorption and is a prerequisite for maintaining good hygiene.

Foamed PVC panels are not eaten by wood eaters, termites, etc. insects and do not rot.

Foamed PVC sheets for the furniture industry are safe for the manufacture of details, as they are non-toxic and do not corrode in contact with most chemicals. Foamed PVC furniture panels provide excellent thermal insulation and are almost non-combustible.

For the production of flat modules – roofs, partitions, railings, portals, game panels, etc., a hydrophobic birch plywood with a thickness of 15 mm is used, treated with three layers of primer and exterior water-based paints and varnishes, meeting the requirements of BDS EN1176-1.

❖ **Components made of rope**

For the production of the rope components, special $\Phi 16$ mm steel wire rope is used. Each of the wires is polyamide braided, which insulates the steel wires.

The connection of individual ropes with the steel fasteners is made through compressed aluminum connections, and the connection between the ropes, where they cross each other, is carried out by special polyamide balls with open-end holes not crossing each other.

❖ **Components of polyethylene**

All polyethylene components (seats, safety caps, plugs) are produced by injection molding of high quality high density coloured polyethylene with the addition of the necessary ingredients to provide the required plasticity and weather and UV resistance.

❖ **Components of rubber**

All rubber components of the equipment are made of coloured styrene butadiene rubber SDR with shore 80 hardness, meeting the requirements for weather and UV resistance.

❖ **Fiberglass slides**

For the production of the slides, high quality polyester resins with the necessary pigments and additives for colour and plasticity are used. The whole structure is multilayered and reinforced with fiberglass mat. The working surface and edges are extremely smooth and treated with polyester gel.

All materials that are used in the production of the slides meet the requirements of BDS EN71-3.

All geometric dimensions of the slides meet the requirements of BDS EN1176-1 and BDS EN1176.

All geometric dimensions of the slide meet the requirements of BDS EN1176-1 and BDS EN1176-3.

❖ Assemblies

For assembling the individual modules and structure, metal threaded galvanized fasteners with M8, M10 and M12 are used. All heads of screws and nuts that have no flat configurations and are designed for a special tool, are concealed with special caps.

For mounting some modules to the structure, galvanized angle plates of the required thickness are used, which provides the strength properties of the module.

❖ Instalatons parts

The connection of the equipment with the ground is done by hot galvanized metal embedded parts that are connected with the columns of the equipment and modules, which are connected to the ground by means of metal bolts and nuts with heads insulated by caps.

II. INSTRUCTION FOR INSTALLATION OF THE EQUIPMENT

The installation of the equipment to the existing terrain is performed as follows:

When installing on a reinforced concrete slab with a thickness of at least 10 cm (according to the constructive opinion of the equipment), the installation is performed by certified segmented anchors. After tightening the anchors, the protruding part is cut out and, after applying the impact absorbing rubber covering, the entire anchoring zone is covered and aligned with the covering with a special rubber jointing mixture.

When installing on a lawn or a terrain with bulk covering (sand or chips), attachment of the equipment is performed by cement stabilization with concrete foundations according to the foundation plan below. The connection of the structure and the concrete foundations is made by metal pillars with welded reinforcement in the area of the foundation. Depending on the type of equipment, these embedded items are a continuation of the supporting pillars (when the equipment has a metal structure) or are a separate element connecting the wooden structure to the foundations. In the case of bulk impact absorbing covering, the supporting metal pillars are stretched depending on the thickness of the covering, so that the foundations can be casted into solid support soil. After the installation of the equipment, the concrete foundations are covered with soil or bulk covering to the level of the terrain.

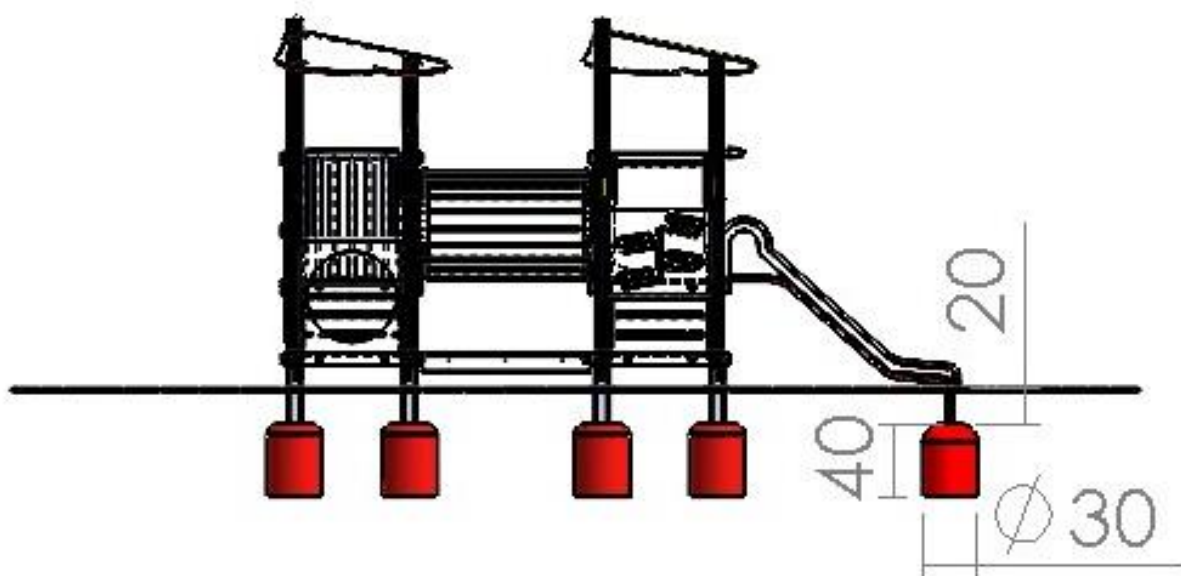

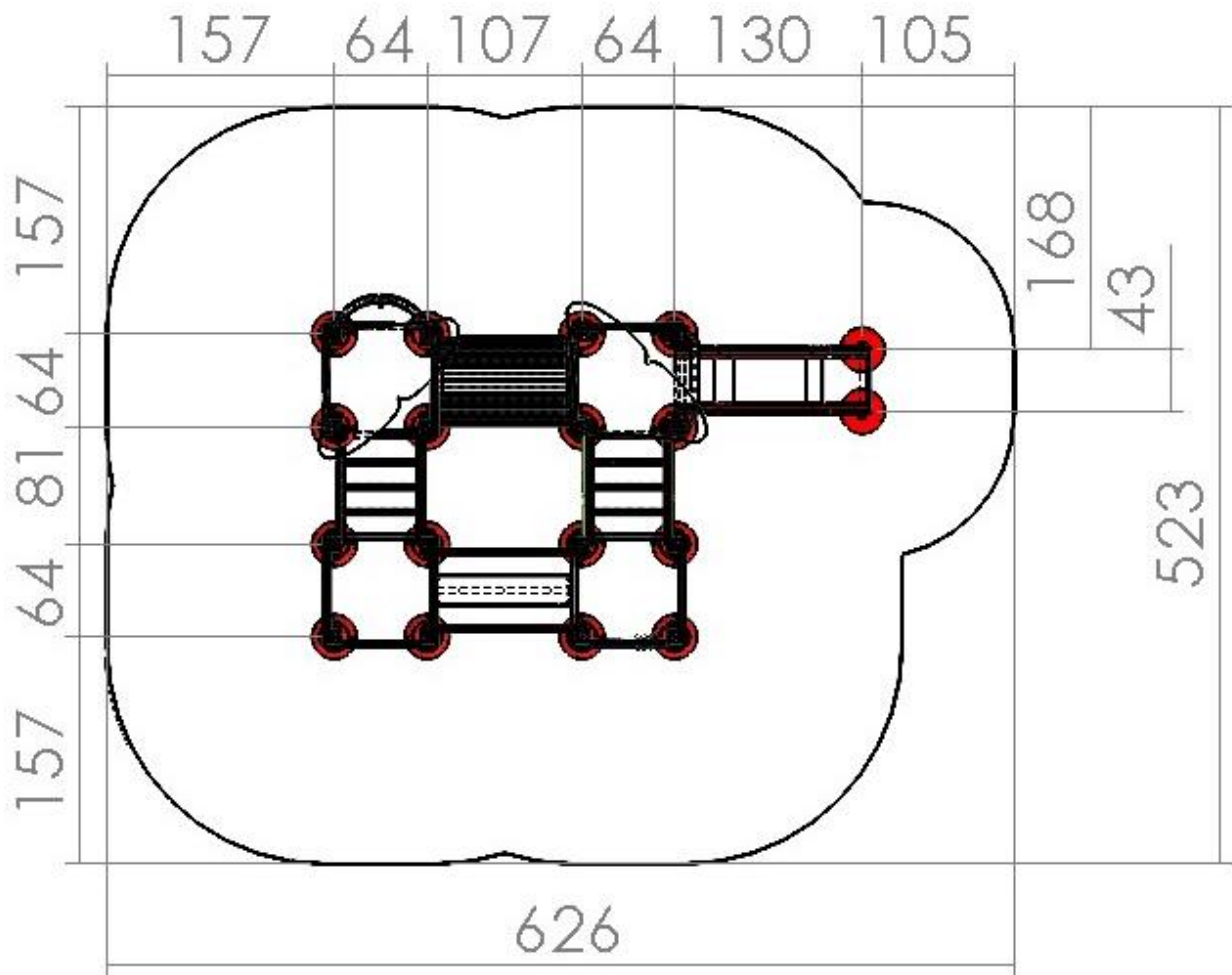

III. OPERATING AND MAINTENANCE INSTRUCTION OF THE SLIDE EQUIPMENT

1. The commissioning of the installed equipment by cement stabilization with concrete foundations shall be performed after the final maturing of the concrete (not less than 48 hours after its washing).

2. The use of the equipment is unacceptable prior to providing the foreseen in the project corresponding impact absorbing covering and the minimum fall and play area provided in this Technical Specification.

3. In order to achieve a longer operating life, it is necessary to perform periodic maintenance of the equipment.

- Despite the fact that the wood used for production is selected and dried, it is a natural material that is expected to expand and collapse over time and it is therefore necessary in the periodic checks described below to check the tightness of the bolt connections and in case of necessity to be tightened.

- It is necessary to periodically clean the equipment from sand and other solid particles, which accelerate the wear of the horizontal or sloping surfaces.

- Once every two or three years is performed refresh varnish coating.

- During the winter period it is undesirable to cover the equipment with waterproof coatings because the retention of moisture worsens the preservation conditions.

- It must be borne in mind that wood as a material is subject to natural cracks which do not alter its functional and constructive functions. Of course, this is not about cracks that lead to the risk of injuries and other problems for the playing children.

- The repairs or reconstruction of the equipment by unauthorized specialists are unacceptable.

- Replacement of wearing components should be performed with analogous to those that are installed.

IV. GENERAL INSTRUCTIONS FOR MAINTENANCE OF THE EQUIPMENT

> According to BS EN 1176 and Ordinance № 1 of January 12th, 2009 on the Terms and Conditions for Playgrounds Structure and Safety (State Gazette, issue 10/2009) the equipment is subject to regular, periodic and annual monitoring.

- The regular monitoring is carried out by the owner of the playground once every 7 - 10 days in order to examine for any obvious dangers.

- The periodic monitoring is carried out by the owner of the playground once every 1 - 3 months depending on how often the playground is visited. The periodic monitoring is carried out for the purpose of detailed examination of the functioning and stability of the play facilities due to their wearing.

- The annual monitoring is carried out for the purpose of complete and detailed examination of the overall level of safety on the playground, which should comply with the requirements of the above-mentioned Ordinance.

> In case of any troubles, measures to eliminate the identified hazards and risks for the safe operation of the playground should be taken.

V. GUARANTEE CARD

The warranty period of the product is 24 months from the date of installation.

The warranty period of the performed construction and assembly works - sanding with concrete foundations or anchoring on a reinforced concrete slab is 5 years from the date of commissioning of the site.

The operating period of the product is significantly longer than the warranty period and is largely dependent on the periodic maintenance of the equipment described in the operating instructions and the technical specification.

The warranty period covers the following defects:

- Defects of poor manufacturing quality of the product
- Defects of poor quality materials
- Defects due to poor installation

Product warranty does not apply in the following cases:

- If the product is assembled or installed in a manner contrary to the manufacturer's instructions (when installed by the customer)
- Damages to the product caused by vandalism
- Damages caused by improper use not in accordance with the manufacturer's recommendations stated in the operating instructions
- If the buyer has not performed the necessary checks and maintenance of the product in accordance with the manufacturer's recommendations stated in the operating instructions
- In the case of normal wear and tear resulting from the use of the product for its intended purpose, such as scratches, dents, abrasion, fading, cosmetic problems of surface corrosion, micro cracks in wood not affecting the strength and safety of the product.
- Hidden defects in installation work in anchoring due to a poorly executed concrete foundation (slab) by the client. Such a problem may occur with insufficient covering thickness or poor quality concrete.

.....
For company: "IMPRESIA 99" OOD